



P516-129



AD-200 AD-201

Offline lock user guide
Instructions for AD-Series offline locks

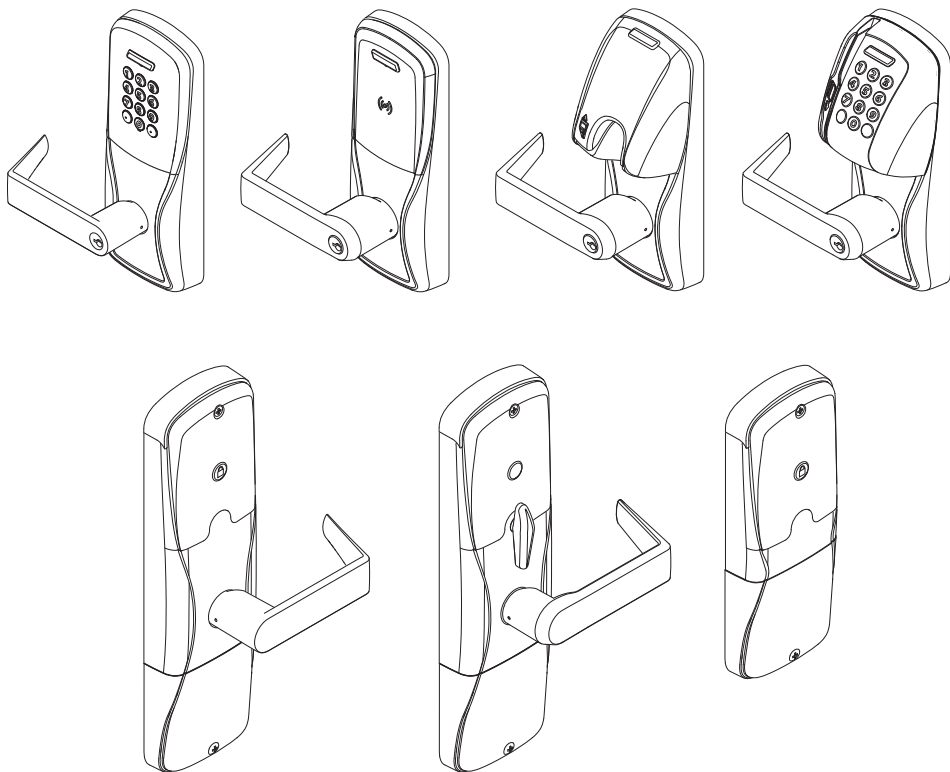

Para el idioma español, navegue hacia www.schlage.com/support.
Pour la portion française, veuillez consulter le site www.schlage.com/support.

Contents

Overview	3
Getting started	4
Schlage Utility Software (SUS)	4
Construction access mode	5
Create the master construction credential - locks with card readers	5
Add construction access mode user credentials - locks with card readers	5
Cancel construction access mode	5
Locks with keypads	5
Manual lock programming	6
Credential types	6
Programming Legend	6
Error codes	9
Test lock operation	10
Mechanical test	10
Electronic test	10
Normal lock operation	11
Reset to factory defaults	11
Level 1 factory default reset	11
Level 2 factory default reset	11
Batteries	12
To install or replace batteries	12
Low battery indications	12
Battery failure modes	13
External power supply	13
LED Reference	14
Schlage button	14
Optional Inside Push Button (IPB)	14
Troubleshooting	15
FCC Statements	16

This product is compliant of UL 294 and ULC S319 standard. This product's compliance would be invalidated through the use of any add-on, expansion, memory or other module that has not yet been evaluated for compatibility for use with this UL Listed product, in accordance with the requirements of the Standards UL 294 and ULC S319. This product has been evaluated for CAN/ULC-S319 Class 1.

Overview

The Schlage AD-200/AD-201 is an off-line electronic lock in the AD-Series product line.

The Schlage AD-201 is a FIPS-201 certified off-line electronic lock.

- May be powered by batteries or connected to external power using a UL294 or ULC S318/ULC S319 listed power supply capable of sourcing at least 250 mA @ 12 or 24 VDC. See *Batteries* on page 12, or *External power supply* on page 13 for more information.
- Outside lever is normally locked.
- Inside lever always allows egress.
- The lock maintains an audit trail of events.
- Configured using the Schlage Utility Software (SUS). See *Schlage Utility Software (SUS)* on page 4 for more information.

Outside

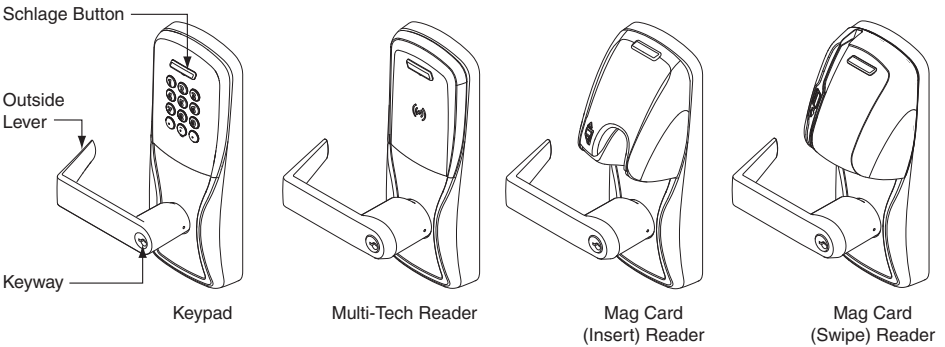

Inside

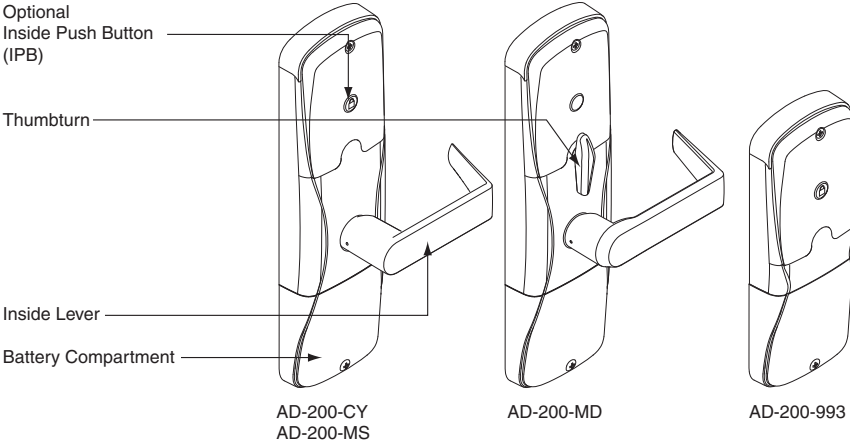

Additional AD-200 reader options: Mag + Keypad, Multi-Tech + Keypad

Note: Proximity card (PR, PRK) ONLY and Smart card (SM, SMK) ONLY readers have been discontinued and replaced by the Multi-Tech (MT, MTK) readers that provide all the same functionality as the original Proximity and Smart card readers in a single credential reader.

Getting started

Follow these steps when setting up a new lock.

1. Install the lock. See the installation guide that came with the lock, or visit www.schlage.com/support, for more information.
 2. Make sure the batteries are installed properly. See *Batteries* on page 12 for more information.
 3. Configure the master construction credential (where applicable). See *Construction access mode* on page 5 for more information. The lock should remain in construction access mode until you are ready to set up the rest of the system.
 4. Test the lock for proper mechanical and electronic operation. See *Test lock operation on page 10* for more information.
 5. When ready to set up for normal use, program the user credentials. See *Manual lock programming* on page 6 for more information.
- ① **Programming the lock with the SUS will remove all credentials that were added using the master construction credential.**
6. Consult the SUS user guide for information about configuring the lock.
 7. Familiarize yourself with the information in this guide.

Save this user guide for future reference.

Schlage Utility Software (SUS)

The Schlage Utility Software is used for programming and setup only.

The (SUS) is used to configure locks. This includes transferring data files between the access control software and locks. For information about the SUS, refer to the SUS user guide.

Construction access mode

Construction access mode is used to allow access before the lock has been programmed, and for testing purposes.

- Enabled by default.
- The lock will remain in construction access mode until the mode is cancelled as described below.
- No audits are captured while lock is in construction access mode.

Create the master construction credential - locks with card readers

The first card presented to a new lock automatically becomes the master construction credential!

1. Press and hold the Schlage button while presenting a credential.
2. This credential becomes the master construction credential and is used to program construction access.
3. The Schlage button will blink green on the left and right as confirmation.

After you have created the master construction credential, you can then use that card to add construction access mode user credentials.

- ① **The master construction credential will not grant access. It is used only to add additional credentials.**

Add construction access mode user credentials - locks with card readers

1. Present the master construction credential to the lock. The schlage button will light.
2. Present the user credential to be added within twenty (20) seconds. The user credential will be added to the lock database.
3. Repeat for additional user credentials.

- ① **Credentials added using the master construction credential will have normal 24/7 access.**

Cancel construction access mode

Do one of the following:

- Program the lock with the SUS. See the SUS user guide for more information.
- Reset the lock to factory settings. See *Reset to factory defaults on page 11* for more information.

When construction mode is cancelled, the master construction credential and all other credentials added using the master construction credential will no longer function.

Locks with keypads

In the factory default state, offline locks with keypads, with or without additional credentials, have a default PIN of 13579 and “#”, which can be used for installation, testing and construction access. To test, enter default PIN. The Schlage button will blink and the lock will unlock.

The default PIN, 13579 and “#” is automatically deleted when a construction access user credential is added to the lock, or a new programming credential is created, or the lock is programmed with the SUS.

TIPS

Use the same Master Construction Credential for all the locks in the facility.

If you present the first card to a new lock to create the Master Construction Credential and the card is not accepted, the lock has either been programmed or already has a Master Construction Credential.

If the Master Construction Credential cannot be located, or to put the lock back into construction access mode, reset the lock to factory settings. See *Reset to factory defaults* on page 11 for more information.

Manual lock programming

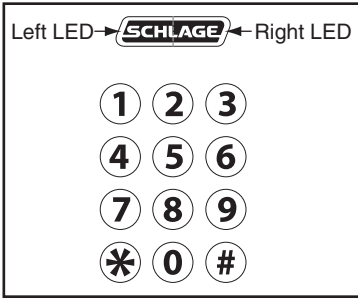

TIPS

The Schlage button has two different LEDs, one on the left and one on the right. Press the Schlage button to activate the keypad backlight.

All locks have a default programming code of 97531 and “*”.

All locks have a default normal use code of 13579 and “#”.

When adding a card credential, the 3-6 digit code (PIN) entered prior to presenting the card becomes the credential reference number. This number can be used to delete a card without physically having the card. Keep a log of all issued credential reference numbers and codes for future reference.

Credential types





Credential type	Function	Description
Programming (code or card)	Used to program the lock. Does not unlock the lock.	Five-digit code and “*” OR card
Normal Use	Unlocks the lock momentarily.	PIN (3 - 6 digits) OR card
Normal Use +PIN		PIN (3 - 6 digits) AND card
Toggle	Changes the state of the lock from locked to unlocked, or vice versa, unless in a Freeze state.	PIN (3 - 6 digits) OR card
Toggle +PIN		PIN (3 - 6 digits) AND card
Freeze	Freezes the lock in the current state. Lock remains frozen until Freeze credential is presented again.	PIN (3 - 6 digits) OR card
Freeze +PIN		PIN (3 - 6 digits) AND card
Pass-through	Unlocks a lock momentarily, regardless of state. Overrides a lock in Freeze state.	PIN (3 - 6 digits) OR card
Pass-through +PIN		PIN (3 - 6 digits) AND card

Programming Legend







Symbol	Description
[Programming Code]	Five-digit code, identical to programming credential code listed in the credential types table.
Programming Card	Programming card, identical to programming credential card listed in the credential types table.
[PIN]	Three- to six-digit code. A PIN can be any of the PIN code types listed in the credential types table. A PIN entered before a card credential becomes the credential reference number.
*	Asterisk key on the keypad
0 - 9	Number keys on the keypad
	Schlage button

Manual programming commands



- ① Commands are confirmed by five left-right green blinks of the Schlage button.
- ① Programming mode will time out if no entry is made in 20-25 seconds. Time out is indicated by red blinks of the Schlage button, three left and nine right at the same time.
- ① An incorrect entry is indicated on the Schlage button by a solid red left LED, and a blinking green right LED. To interpret blink patterns, refer to *Error codes on page 9*.

Function	Press/Present	Wait for confirmation ¹
Change [Programming Code]	[Programming Code] * OR Programming Card	Wait for  to stop flashing between each step.
	⑦ *	
	New [Programming Code] *	
	New [Programming Code] *	
Change Programming Card	[Programming Code] * OR Programming Card	Wait for  to stop flashing between each step.
	⑦ *	
	New Programming Card	
Add Normal Use Credential	[Programming Code] * OR Programming Card	Wait for  to stop flashing between each step.
	③ *	
►New [PIN] *	
	* (for PIN only) OR New Card	
add another credential OR * to finish	
Add Normal Use +PIN Credential	[Programming Code] * OR Programming Card	Wait for  to stop flashing between each step.
	③ ③ *	
	③ ① ① *	
►New [PIN] *	
New Card	
add another credential OR * to finish	
Add Toggle Credential	[Programming Code] * OR Programming Card	Wait for  to stop flashing between each step.
	③ ③ *	
	① ⑨ ① *	
►New [PIN] *	
	* (for PIN only) OR New Card	
add another credential OR * to finish	

¹ Other lights may show before the final confirmation. Wait for the final confirmation before continuing to the next step.

Function	Press/Present	Wait for confirmation ¹
Add Toggle +PIN Credential	[Programming Code] * OR Programming Card	Wait for  to stop flashing between each step.
	3 3 *	
	3 9 1 *	
	→ New [PIN] * New Card	
	add another credential OR * to finish	
Add Freeze Credential	[Programming Code] * OR Programming Card	Wait for  to stop flashing between each step.
	3 3 *	
	1 1 5 *	
	→ New [PIN] * * (for PIN only) OR New Card	
	add another credential OR * to finish	
Add Freeze +PIN Credential	[Programming Code] * OR Programming Card	Wait for  to stop flashing between each step.
	3 3 *	
	3 1 5 *	
	→ New [PIN] * New Card	
	add another credential OR * to finish	
Add Pass Through Credential	[Programming Code] * OR Programming Card	Wait for  to stop flashing between each step.
	3 3 *	
	1 1 9 *	
	→ New [PIN] * * (for PIN only) OR New Card	
	add another credential OR * to finish	
Add Pass Through +PIN Credential	[Programming Code] * OR Programming Card	Wait for  to stop flashing between each step.
	3 3 *	
	3 1 9 *	
	→ New [PIN] * New Card	
	add another credential OR * to finish	
Delete Credential	[Programming Code] * OR Programming Card	Wait for  to stop flashing between each step.
	5 *	
	→ Credential [PIN] *	
	delete another credential OR * to finish	

1 Other lights may show before the final confirmation. Wait for the final confirmation before continuing to the next step.

Function	Press/Present	Wait for confirmation ¹
Change Relock Time	[Programming Code] * OR Programming Card	Wait for  to stop flashing between each step.
	9 9 *	
	1 *	
	Each button press adds to the total delay time Example: 1 + 9 adds a 10 second delay	
	* to finish	
Change PIN Length	[Programming Code] * OR Programming Card	Wait for  to stop flashing between each step.
	9 9 *	
	4 *	
	Press 3, 4, 5, OR 6 for desired PIN length	
	* to finish	
¹ Other lights may show before the final confirmation. Wait for the final confirmation before continuing to the next step.		

Error codes

- ① All error codes are indicated on the Schlage button by a solid red left LED, and a blinking green right LED. The number of green blinks indicates the error code.

Number of green blinks	Error code description
1	Computer programming error (not complete).
2	Too long programming/user code entered. Programming code must be five (5) digits. User code length cannot exceed six (6) digits.
3	Memory full, too many codes. Delete some codes.
4	Programming code cannot be deleted, only changed.
5	Programming code entries do not match. Programming code not changed.
6	Invalid command. Invalid function code entered.
7	Code not found.
8	Code too short. Programming code length must be five (5) digits. User code minimum length is three (3) digits.
9	Not a unique code.
10	Manual programming not allowed.

Test lock operation

If you encounter problems while performing any of the following tests, review the installation guide and correct any problems.

Mechanical test

1. Rotate the inside lever. Operation should be smooth, and the latch should retract.
2. Insert the key into the keyway and rotate the key or the key and lever to open the door. Operation should be smooth, and the latch should retract.

Electronic test

Test the AD-200/AD-201 in factory default mode

1. For locks with a keypad, press any number key. The lock will beep.
2. Press the Schlage button. The keypad should light blue for a few seconds.
3. For locks with a card reader, present a credential to the reader. The lock will beep and the left side of the Schlage button will blink red one time. When the lock is in factory default mode, no credentials are accepted.
4. In the factory default state, locks with keypads, with or without additional credentials, have a default PIN of **13579** and "#". To test, enter the default PIN. The Schlage button will blink and the lock will unlock.

Test the AD-200/AD-201 in construction access mode

1. When the master construction credential is presented, the lock will beep and the Schlage button will light green for 20 seconds awaiting the presentation of another credential to be granted Construction User Access.
2. When a valid construction access user credential is presented, the lock will unlock for the re-latch delay period (default three seconds), and the left side of the Schlage button will blink green. When the lock re-locks after the re-latch delay period, the left side of the Schlage button will blink red.
3. If an invalid construction access user credential is presented, the lock will beep and the left side of the Schlage button will blink red one time. See *Construction access mode* on page 5 for more information.

- ① **NOTE: Construction access mode is cancelled when the lock is reset to factory defaults. When construction access mode is cancelled, the master construction credential and all other credentials added using the master construction credential will no longer function.**

Normal lock operation

After credentials have been programmed, present credentials to operate the lock as follows:

Credential type	Action
Credential	Present credential to reader → Green blink and access granted
+ PIN Credential	Present credential to reader → Press PIN ¹ → Green blink and access granted

¹ The default PIN length is six digits. The “#” key must be used as an ENTER key for PINs with fewer than six digits. PIN length can be manually configured (refer to *Change PIN Length* on page 9).

Reset to factory defaults

All information in the lock will be deleted and reset to factory defaults!

Level 1 factory default reset

- ① **Level 1 factory default reset will delete configurations and settings in the main controller in the lock.**
- ① **Main controller configurations that will reset to factory default include: programming and user codes.**
- ① **Level 1 factory default reset *will not* reset configurations and settings in the reader.**
 1. Remove the top inside cover.
 2. Press and hold the Schlage button until two (2) beeps sound (10 seconds).
 3. Release the Schlage button.
 4. Press and release the inside push button (IPB) three (3) times within 10 seconds. One beep will sound and one red blink will occur with each press.
 5. The Schlage button and IPB will both light green for one second and a one-second beep will be heard. This indicates that the lock has been reset.
- ① **If the IPB is not pressed 3 times within 10 seconds, two beeps with two red blinks indicate timeout.**
- 6. Replace the top inside cover.

Level 2 factory default reset

- ① **Level 2 factory default reset will delete all configurations and settings in the lock and the reader.**
- ① **Reader configurations that will reset to factory default include: keypad format, magstripe reader track, beeper on/off, and contactless card.**
- ① **Days in Use counter and lock type configurations will not reset.**

To complete Level 2 factory default reset, repeat steps 2 through 5 above **within 10 seconds of the confirmation signals of Level 1 factory default reset**. If more than 10 seconds pass after the confirmation signals of Level 1 reset, then Level 1 reset will be repeated.

Batteries

To install or replace batteries

① **Replacement of batteries does not affect any programmed data.**

① **Battery voltage can be checked with the SUS.**

1. Remove the battery cover.
2. Remove the battery bracket.

Do not allow the battery pack to hang from the wires.

3. Install the new batteries (install only new AA Alkaline batteries).
4. Reinstall the battery pack and battery bracket.
5. Reinstall the battery cover. **Be careful not to pinch the battery wires when installing the battery cover.**

CAUTION! Danger of explosion if battery is incorrectly replaced! Replace only with the same or equivalent type. Dispose of used batteries according to the manufacturer's instructions.

This product has been evaluated for ULC-S319 compliance with Duracell Procell PC1500 AA alkaline batteries and Panasonic CR2025 lithium coin cell. For installations requiring ULC-S319, these battery models should be used.

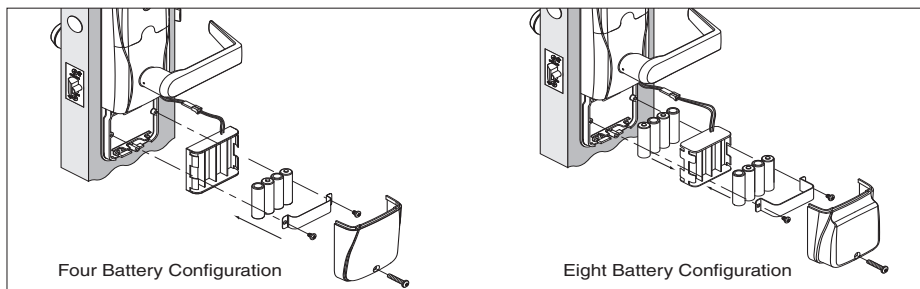

Low battery indications

① **During low battery condition, the reader's beeper will be temporarily disabled. This condition will revert to normal function when batteries (AA or coin cell) are replaced. (While the beeper is in temporary disabled state, the SUS will indicate beeper is "on" as previously set by the user.)**

Condition	Indicator	Solution
Batteries low	After credential is presented, 9 red blinks of Schlage button. (Left = AA, Right = Coin Cell), then normal indicator.	Replace batteries immediately to avoid battery failure. Lock is intended to operate for 500 cycles in low battery condition.
Battery failure (configured by SUS)	No LED or beeps Valid credentials do not grant access	Replace batteries immediately. Mechanical override key must be used to unlock the lock.

Battery failure modes

- ① The battery failure mode is set using the SUS. See the SUS User Guide for more information.

Mode	Description
Fail As-Is (default)	Lock remains in current state until batteries are replaced.
Fail Unlocked ¹	Lock unlocks and remains unlocked until batteries are replaced.
Fail Locked ¹	Lock locks and remains locked until batteries are replaced.

¹ Fail Unlocked and Fail Locked modes are not available if the lock is externally powered.

External power supply

The AD-200/AD-201 may be connected to external power using a UL294 listed Power Supply for UL installations, and a power supply that complies with CAN/UL-S318 or CAN/ULC-S319 for cUL installations. The power supply must be capable of sourcing at least 250 mA @ 12 or 24 VDC (Schlage PS902, PS904, PS906).

- ① When powered with external power supply, the lock will always fail “As-Is” if power is lost.

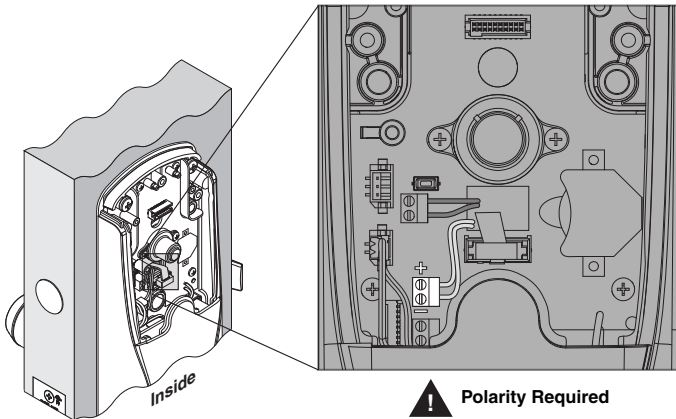

LED Reference

Most LED and beep indicators are configured using the SUS. See the SUS user guide for more information.

Schlage button

Condition	Lights
Access denied	2 red blinks
Access denied, user outside time zone	4 red blinks
Valid PIN entered while lock in freeze mode	12 red blinks indicating lockout
Factory default reset	Solid red while clearing memory, then a one-second solid green when complete.
Waiting for PIN (Card + PIN)	5 left red with right green blinks, then solid right green
Low battery indicator, AA batteries	9 left red blinks
Low battery indicator, coin cell battery	9 right red blinks
Momentary unsecured access	1 green blink, then one red blink on relock
Toggle unsecured	2 green blinks
Toggle secure (relocking)	1 red blink
SUS authentication	Left green solid
USB active with no physical connection	Left green blinking

Optional Inside Push Button (IPB)

Action	Lights
Classroom, Office or Apartment Mode	
Press IPB to lock	1 red blink
Press IPB to unlock	1 green blink
Privacy Mode	
With door closed, press IPB to engage privacy	4 green blinks
With door closed, press IPB to release privacy ¹	4 red blinks

¹ If DPS is used, then opening the door will also release privacy. If mortise deadbolt is used, then retracting the deadbolt will also release privacy.

Troubleshooting

Problem	Possible cause	Solution
<p>The lock beeper does not sound and the keypad does not light when the Schlage button is pressed.</p>	<p>The reader may not be properly seated into the front escutcheon.</p> <p>The reader connector may have bent pins.</p> <p>The through door ribbon cable may not be properly plugged in.</p> <p>The battery or wired power may be improperly connected.</p> <p>The batteries may be inserted with incorrect polarity.</p>	<p>Check that the reader is fully seated into the front escutcheon.</p> <p>Check that there are no bent pins in the reader connector.</p> <p>Check that the through door ribbon cable is plugged in correctly. The red wire should be on the left and not pinched in the door.</p> <p>Check that the battery or wired power is connected correctly.</p> <p>Check that the batteries are inserted in the correct polarity.</p> <p><i>Refer to the installation instructions that came with the AD-200/AD-201 lock, or this user guide for details on the above mentioned procedures.</i></p>
<p>The reader is not working.</p> <p>The Smart card is not reading.</p> <p>The magnetic swipe card is not reading correctly (no beeps or blinks).</p>	<p>The through hole ribbon cable may be pinched.</p> <p>The Smart card default of the card reader may not be correct for the Smart card.</p> <p>The “Mag Track in Use” default for all Magnetic Card Credential Readers is “Track2”. The magnetic swipe card data may be on Track1 or Track3.</p>	<p>Check that the through hole ribbon cable is not pinched.</p> <p>Change the Smart card format using the SUS. Select AD-200/AD-201 “Lock Properties”, “Reader” tab, and “Smart cards in use”.</p> <p>Use the SUS to change “Mag Track in Use”. Select AD-200/AD-201 “Lock Properties”, “Reader” tab, and “MAG Card Track selection”.</p> <p><i>Refer to the installation instructions that came with the AD-200/AD-201 lock, or the SUS user guide for details on the above mentioned procedures.</i></p>

FCC Statements

Allegion Agency Statements

Compliance Statement (Part 15.19)

This device complies with Part 15 of the FCC Rules.

Operation is subject to the following two conditions:

1. This device may not cause harmful interference, and
2. This device must accept any interference received, including interference that may cause undesired operation.

Customer Service

1-877-671-7011 www.allegion.com/us



© Allegion 2014
Printed in U.S.A.
P516-129 Rev. 03/14-h